

601360C

Floor Mounted Tub Filler

FINISHES

- 601360CPC Polished Chrome
- 601360CBG Brushed Gold
- 601360CBB Brushed Black

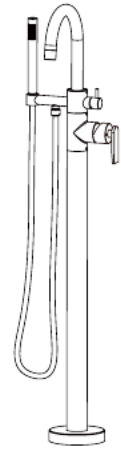

STANDARDS

- Compliant with ASME A112.18.1 - CSA B125.1
- ADA Compliant

FEATURES

- Solid Brass Construction
- Single Control Ceramic Disc Valve
- Flow rate 7.0 GPM @ 60 PSI
- Hand Shower 1.8 gpm @ 80 PSI
- Step-By-Step Installation Instructions

DIMENSIONS

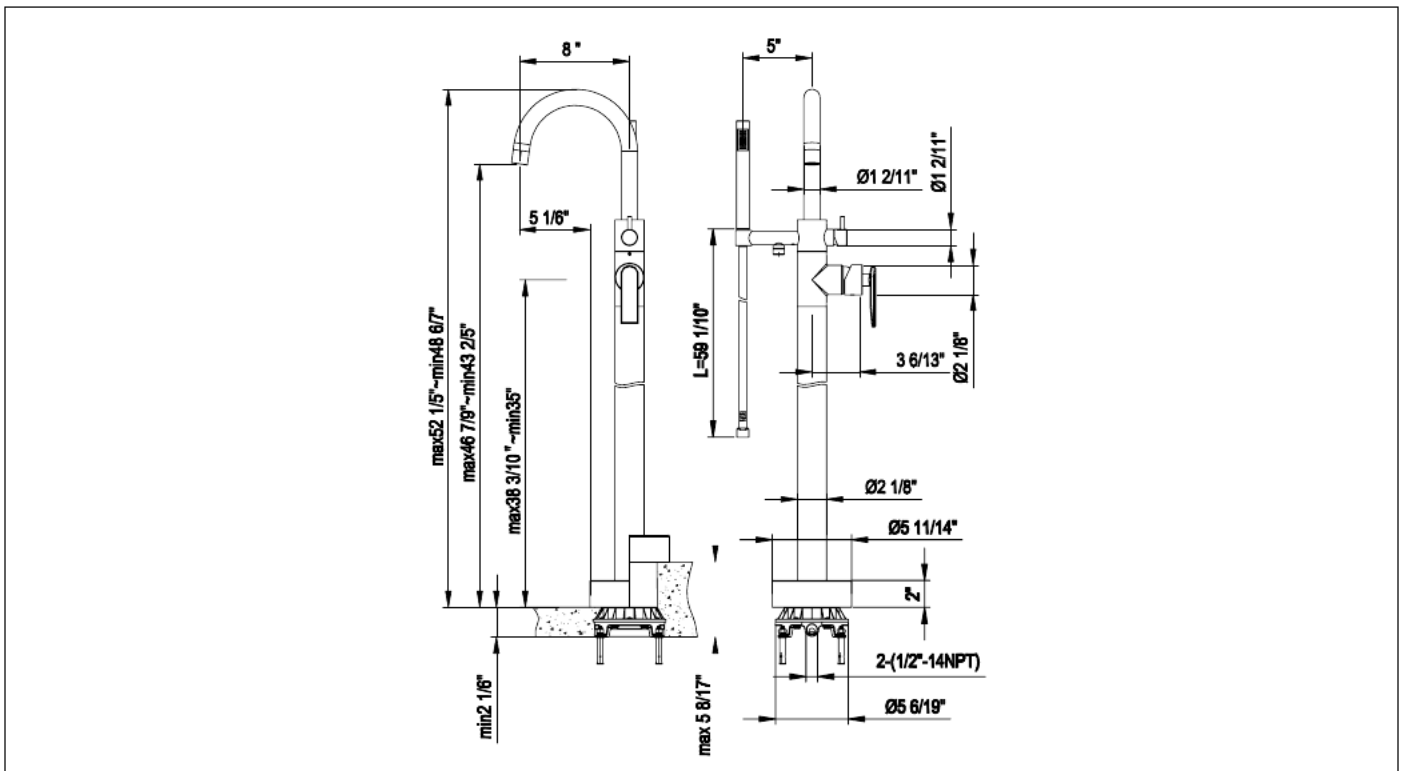

Project _____
 Contractor _____